



Opening Size Up To 70" wide Up To 80" high

MINI CLEARVISION ROLLING SHUTTER

Specification:

Slat:

1 1/2" UV stabilized polycarbonate with a 1/2" aluminum joiner. Interlocking nylon end clips fitted to end of each slat.

Side Guide (track):

1" x 5/8" extruded aluminum

Bottom Rail:

Extruded aluminum section, 2" high fitted with half-round PVC seal

Operation:

Rolling, spring counter balanced, hand operated or electric, and sliding gravity feed

Locking:

Shoot bolts, polished or plain aluminum standard.L&F flush locks, key operated, T handles, locking or non-locking.

Rolling operating components:

Roller: 3" lightweight aluminum tube encasing helical coil spring.

Brackets:

Fabricate from mild steel to suit applications

Sliding operating components:

Guides incorporating molded nylon corner segments.

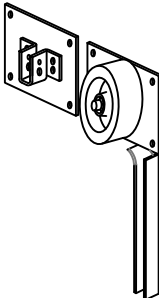
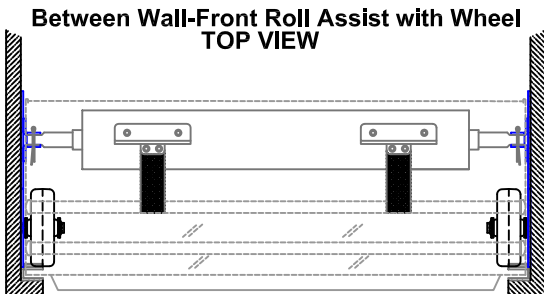
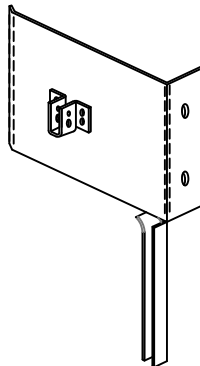
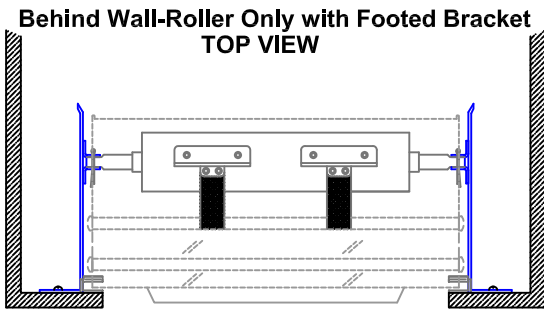
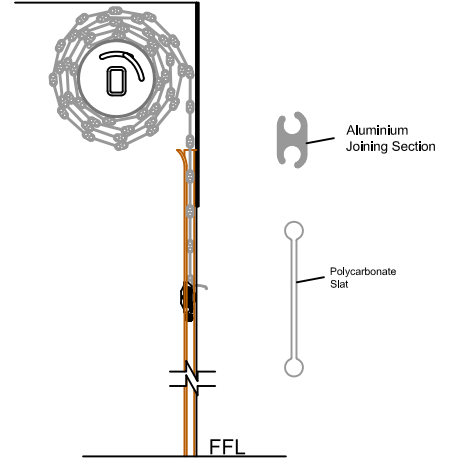
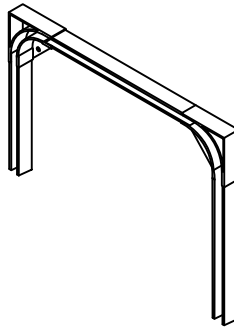
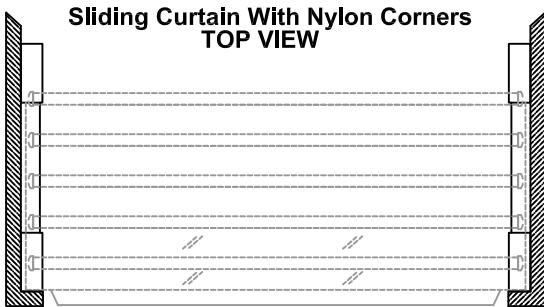

Headroom Table (CV Mini) ROLLER ONLY

Opening Height	Header Required	Roll Diameter
20	6.5	4.5
40	7.5	5.0
60	8.75	5.75
80	9.5	6.5

Headroom Table (CV Mini) FRONT ROLL ASSIST

Opening Height	Header Required	Roll Diameter	Back Room Required
20	3	4.5	8.5
40	3	5.0	9.0
60	4	5.75	9.75
80	4.5	6.5	10.5

GUIDE FIXING

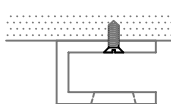

FACE FIXING

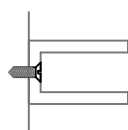

SIDE FIXING

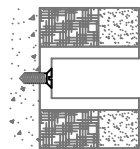

RECESSED